

**TEMPEST**  
GAMING

**UMBRA**

RGB ATX GAMING CASE

ACCESSORY BAG

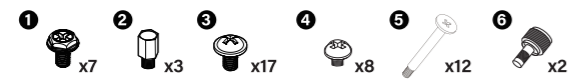

### A. Disassemble the side panel and the front panel

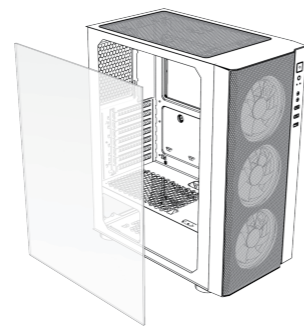

Please take out the screws before disassembling side panels.  
Please remove the side panels before disassembling the front panels.

### B. Install the Power Supply

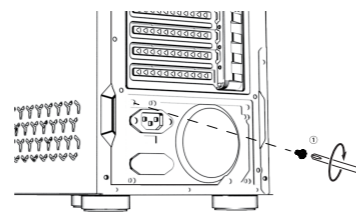

Please make sure that the holes of power supply aim at case cooling vents when installing power supply.

### C. Install the Motherboard

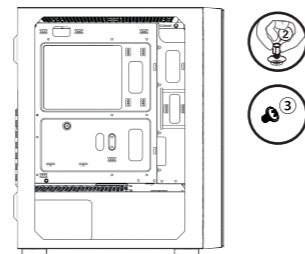

Please make sure that the motherboard aims at the copper cylinder and fix motherboard with No.3 screw.

#### NOTE

If the copper pillar of the case drops off, please fix it with No.2 copper cylinder.

### D. Install Fan and Radiator

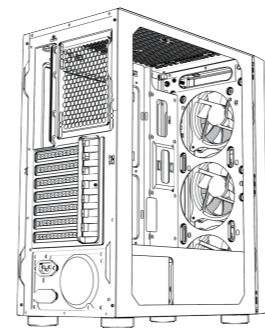

Fan  
Front: 120mmx3  
Rear: 120mmx1  
Top: 120mmx2

### E. Install HDD

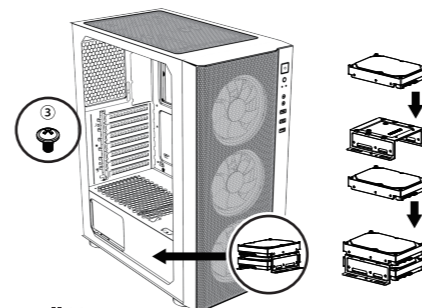

Hard disk enclosure for both SSD and HDD; unscrew hard disk enclosure and install HDD with screws.

### F. Install SSD

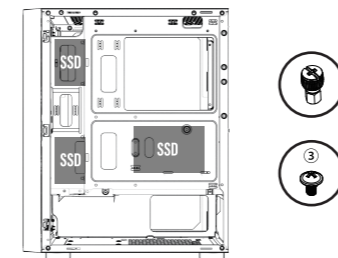

Hard disk enclosure for both SSD and HDD; unscrew hard disk enclosure and install HDD with screws.

### G. Install Graphic card and disassemble the expansion slot

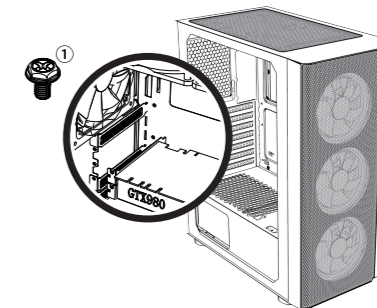

Remove the baffle marked in the picture, make sure the Graphic card aims at the motherboard slot and then fix Graphic card and case with No.1 screw.

Graphic card bracket is equipped, which can be adjusted according to Graphic card location.

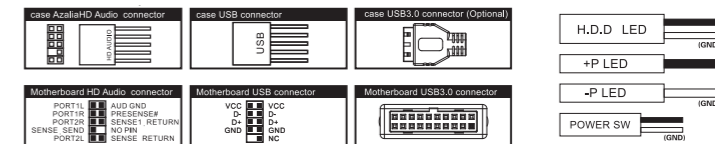
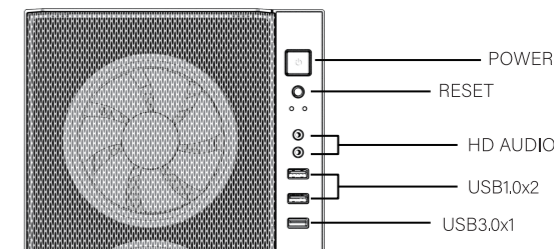

MORE INFORMATION AT [www.tempestofficial.com](http://www.tempestofficial.com)

**TEMPEST**